



Prestan professional AED TRAINER

USE AND CARE INSTRUCTIONAL SHEET

Models PP-AEDT-101 —> Prestan Professional AED Trainer with English/Spanish Module, 4 'C' batteries, one set of adult training pads, one set of extra connector pins, an Instruction Sheet and a nylon carrying case.

Models PP-AEDT-401 —> Prestan Professional AED Trainer Four Pack with English/Spanish Modules, 16 'C' batteries, four sets of adult training pads, four sets of extra connector pins, an Instruction Sheet and a nylon carrying case.



START HERE

- Use this instruction sheet as your first source for information about the Prestan Professional AED Trainer and Accessories.
- **Warning:** The Prestan Professional AED Trainer is intended for the expressed purpose and use of CPR/AED Instructors. It is **NOT** an Automated External Defibrillator (AED) and will not deliver a shock. It should **NEVER** be kept in the same area with AEDs to avoid confusion.
- If you have any problems with the care and use of the Prestan Professional AED Trainer refer to the troubleshooting section, contact your Prestan distributor or call Prestan at 1-800-434-7989

THANK YOU for buying the **Prestan Professional AED Trainer!**

If you have any questions about the **Prestan Professional AED Trainer**, or if you would like to order additional AED Trainers, manikins or any accessories, please contact your distributor of Prestan's Professional Training Products.

For information on Prestan's Profession Training Products Distributors, please contact Prestan Products at 1-800-434-7989. Monday – Friday, 9:00 a.m. to 5:00 p.m. EST or visit Prestan website at www.prestanproducts.com.

FEATURES OF THE PRESTAN PROFESSIONAL AED TRAINER

- Clear & Calm Voice Prompts
- Automatic Pads-On-Manikin Detection
 - Remote Control NOT Required
 - Plugging in connector NOT Required
 - Works on any Manikin
- Five Training Scenarios
- Chest Compression Rate Metronome
 - Recording of the clicker in a Prestan Professional Adult Manikin!
 - Audio Clicker with Count Reminder at 10, 20 and 30 compressions
- Automatic OR Semi-Automatic Shock-Delivery
- Flip Up Lid
 - Sturdy, durable polycarbonate lid & hinge
 - DOES NOT TURN AED TRAINER ON!
- Bright Illuminated Shock Button
 - Flashes when shock is advised
- On/Off Button with Lighted Indicator
 - Simple and Intuitive
- Protective & Reusable Pad Case
- High Performance Training Pads
 - Clear Anatomical Placement Graphics
 - Long-Life Adhesive
 - Adheres well to all Manikins
- Unique Pad Connector
 - With Locking Connector Pin
- Simple Control Panel
 - Language Button
 - Selections Indicator Lights Button
 - Scenario Button
 - Volume Button
 - Pause / Play Button
- Long Battery Life
 - Low Battery Voice Prompt Warning
 - Automatic Shut Off Extends Battery Life
- Water & Splash Resistant

CONTENTS

Check out the contents of the box. Depending on the product, it should contain the following:

PP-AED-100: One Prestan Professional AED Trainer, four (4) "C" batteries (already installed), An English/Spanish language and 2010 Guidelines module, one set of AED Training Pads, one set of extra connector pins and nylon carrying case.

PP-AED-400: Four Prestan Professional AED Trainers, sixteen (16) "C" batteries (already installed), four (4) English/Spanish language and 2010 Guidelines modules, four (4) sets of AED Training Pads, four sets of extra connector pins and one nylon carrying case.

If you are missing anything, please contact your Authorized Prestan Distributor.

PARTS

PROFESSIONAL AED TRAINER

[FRONT OF UNIT]



PROFESSIONAL AED TRAINER

[BACK OF UNIT]

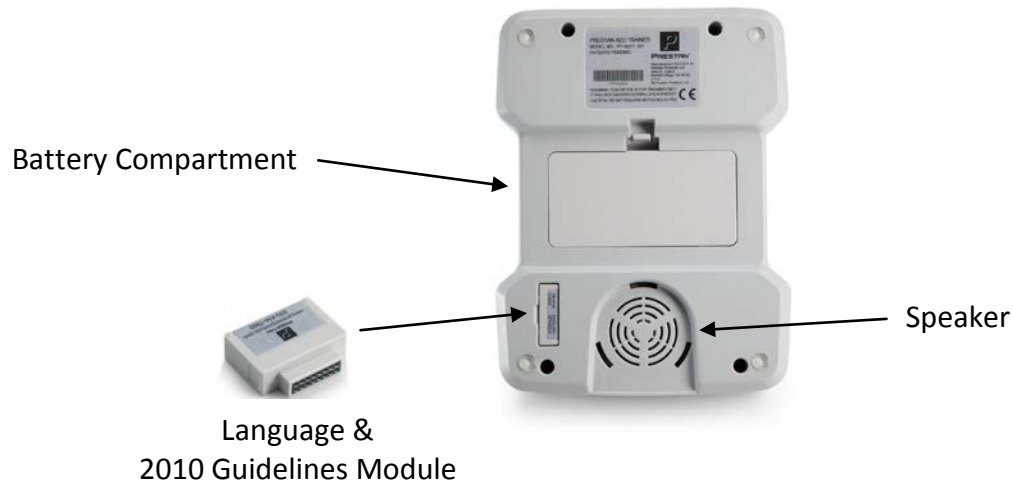

ASSEMBLY, SETUP AND USE

- Remove the contents of the plastic package containing the instruction sheet, module, package of two extra connector pins and set of adult pads from the shipping container
- Remove the cardboard tray from the shipping container
- Remove the PRESTAN PROFESSIONAL AED TRAINER from the box
- Unzip the PRESTAN PROFESSIONAL AED Trainer carrying case
- Remove the PRESTAN PROFESSIONAL AED TRAINER FROM THE CARRYING CASE
- Insert the MODULE with the two languages/2010 Guidelines into the back of the unit on the lower left hand corner
- Pad Assembly
 - Open the plastic package and remove the Prestan Professional Adult Training Pads
 - Find the ends of the AED Trainer cables that are not connected to the unit
 - Remove black pad connector pins by pushing on the small end of the pin with a ball point pen

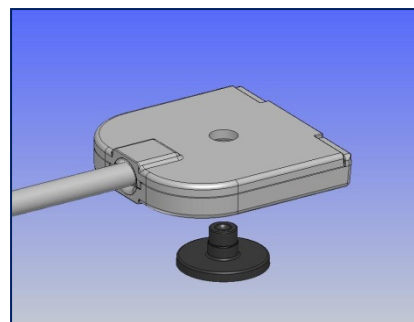
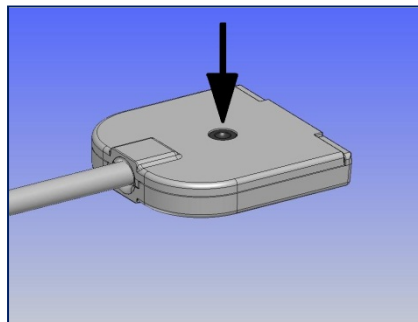

Remove Pin from Connector

Prestan professional AED TRAINER



- Insert pad into cable connector (be sure the pad graphics are on same side as pad connector pin head and the hole in the tab of the pad matches the hole in the connector ends)

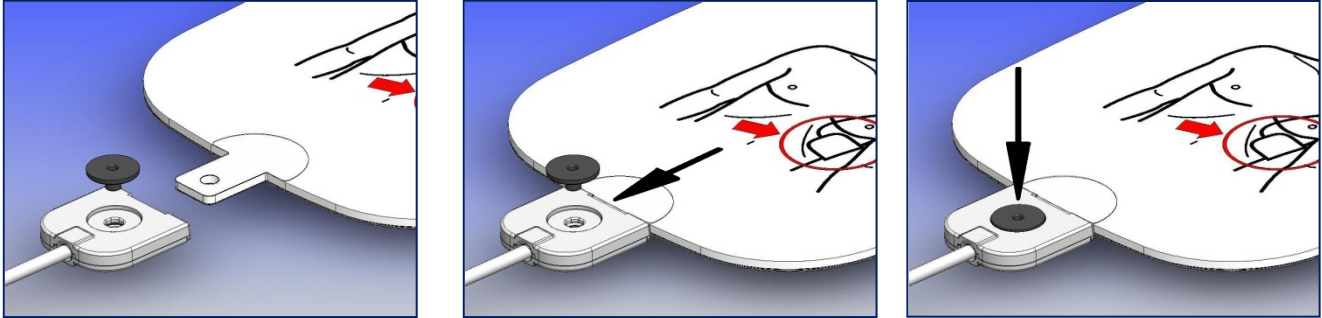

Insert Pad and Pin into Connector

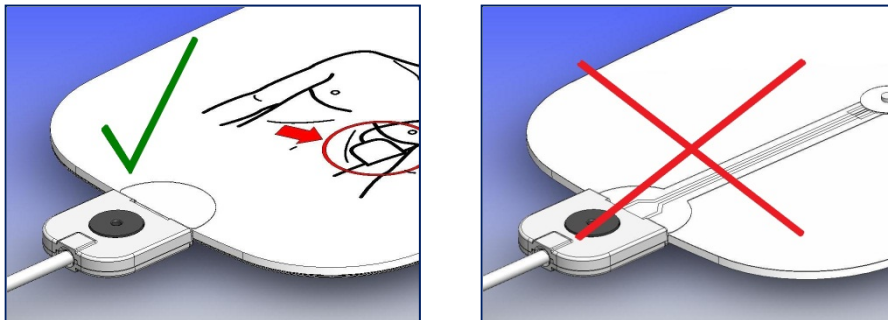

Insure Pad is Not Upside-Down

- Push black pad connector pins back into hole on the end of the pad cable connectors
- Open the white plastic pad carrying case found in the unit

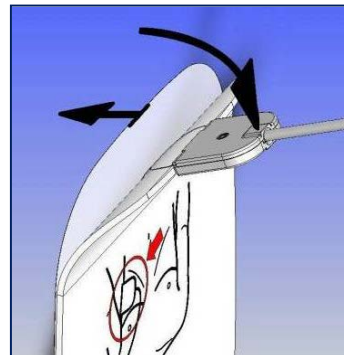

- Then, turn pad over and remove the clear plastic liner from the Adult AED Pad by gently pushing down on the tab end of the pad, causing the liner to separate
- **THROW THE CLEAR PLASTIC LINER AWAY**

Prestan professional AED TRAINER



- Adhere the pads to the INSIDE of the white plastic Pad Case, close the case

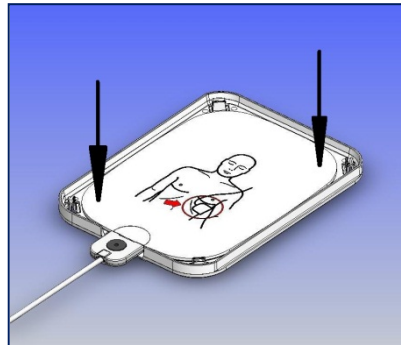
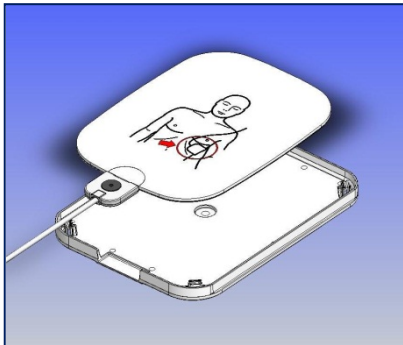

Apply each Pad to inside of Case

Close Case

- Coil the Cables, place them in the well and cover them with the Pad Case

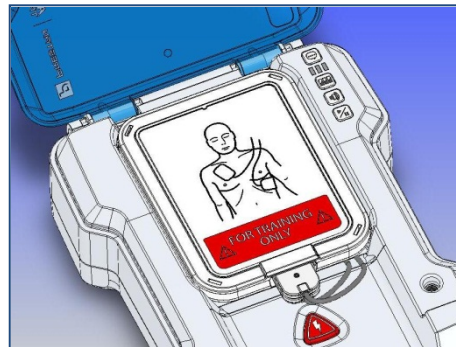
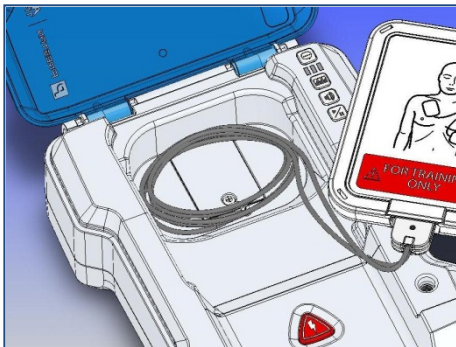

Store Cable and Pads Case

CONTROL PANEL

- Language Button
- Selection Indicator Lights
- Scenario Selection Button
- Volume Button
- Pause Button

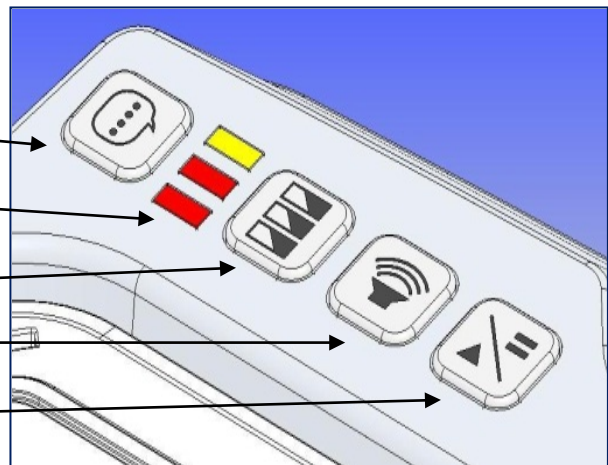

CONTROL PANEL

(Continued)



LANGUAGE SELECTION BUTTON

The LANGUAGE BUTTON is located on the top left hand side of the Prestan Professional AED Unit.

- The language button is there to select the language that the unit will use.
- Simply press the button to toggle between the two languages that come with the unit. (Either English or Spanish)
- The LAST language used on the unit will be used for the FIRST scenarios when the unit starts.
 - You do not have to turn the unit on to change Control Panel selections.

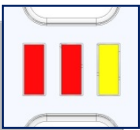

INDICATOR LIGHTS







The indicator lights are on the right hand side of the Prestan Professional AED Trainer in line with the Control Panel buttons

- The indicator lights are used with the Scenario Selection button, the Volume Button, and the Pause Button
- The indicator lights are either red or yellow
- For each function, the indicator lights are defined NEXT
 - They also Indicate semi-automatic or automatic shock delivery mode





SCENARIO SELECTION BUTTON

The SCENARIO SELECTION button is located on the left hand side of the Prestan Professional AED Unit under the Language button

- The scenario selection button is used to select one of the five scenarios available on the unit
-  A red indicator means 'shock'
-  A yellow indicator means 'no shock'
- The indicator is read left to right
-  The default is for three cycles, all of which are for 'shock'
- SCENARIOS
 1.  This scenario is for shock; no shock; no shock
 2.  This scenario is for shock; no shock; shock
 3.  This scenario is for shock; shock; no shock

Prestan professional AED TRAINER



4.  This scenario is for no shock; no shock; no shock
5.  This scenario is for shock; shock; shock

CONTROL PANEL

(Continued)

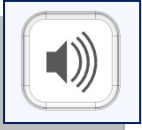

VOLUME BUTTON

- There are three volume levels on the unit
- By pressing the volume button you can increase or decrease the volume of the unit depending on need
- Yellow indicator lights will indicate low volume (1 light), Medium Volume (2 lights), or High Volume (3 lights)



PAUSE/PLAY BUTTON

- When the pause Button is pushed, the unit will pause the scenario
- When in pause mode, three (3) yellow lights in the indicator lights will blink

ADULT TRAINING PADS

- Pads cord is Pre-connected to the AED Trainer
- Pads Sensing System automatically lets the unit know when the pads have been connected to manikin
- Lasts at least 25-30 applications
- Unique pad replacement (see assembly section)
- Pads are kept in a unique white plastic Pad Case



LANGUAGE MODULE

- Contains two languages (English & Spanish)
- Contains current 2010 Guidelines



Automatic/Semi-Automatic

The Prestan AED Trainer can be set to automatically deliver a simulated Shock without depressing the Shock button.

- The AED Trainer is preset from the factory in Semi-Automatic Mode
- To Change this Mode
 - With the AED Trainer off, hold down the On/Off Button until you hear the second

beep, about 10 seconds.

Automatic/Semi-Automatic

(Continued)

- The first beep is for test mode so wait for the second double beep
- The Shock button will flash on and off
- Look at the Selection Indicator Lights
 - If there are three yellow lights – you are in Semi-Automatic Mode
 - If there are three red lights – you are in Automatic Mode
- To change the Mode, Push the shock button
- To Exit and Save, Press the On/Off Button

CLEANING INSTRUCTIONS

The Prestan Professional AED Trainer should be kept clean. If it becomes soiled, simply wipe with a clean, damp, soft cloth. If the Trainer is extremely dirty, common cleaners can be used cautiously with a minimum amount of abrasion to ensure the life of the unit. Do not submerge in water.

PROFESSIONAL AED TRAINER REMOTE

[OPTIONAL – NOT INCLUDED WITH AED TRAINER]

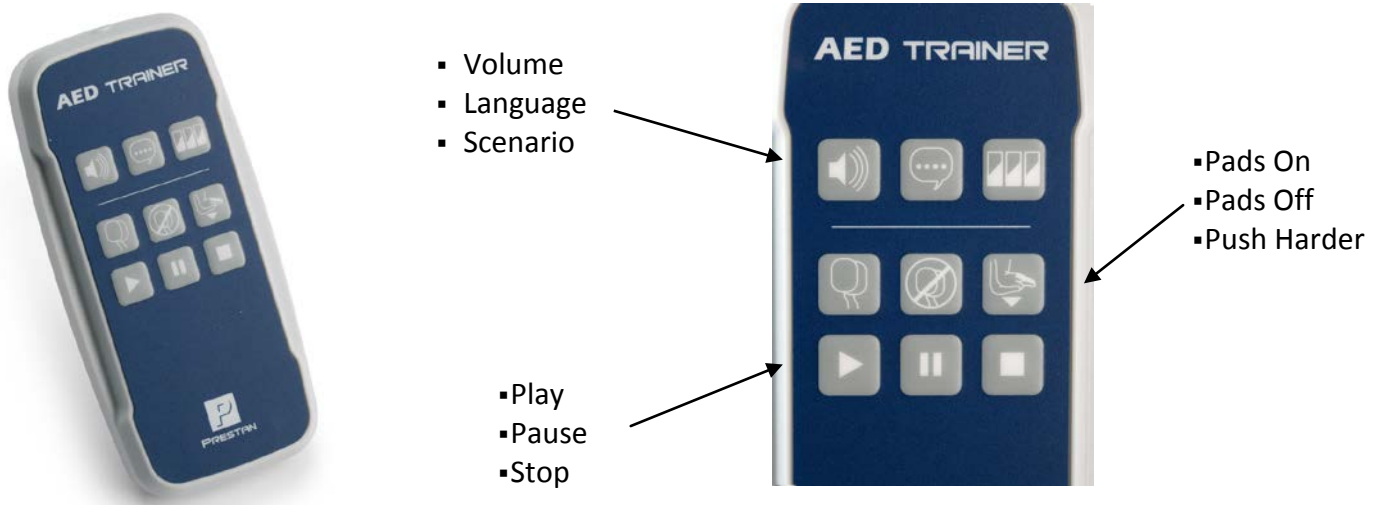

PP-AEDT-100-R Prestan Professional AED Trainer Remote with 2 'AA' batteries (for use with the Prestan Professional AED Trainer)

Prestan professional
AED TRAINER



PP-AEDT-400-R Four Prestan Professional AED Trainer Remotes with 8 'AA' batteries (for use with the Prestan Professional AED Trainer)

Trouble Shooting Guide

SYMPTOM	POSSIBLE ISSUES OR COMMENTS	SOLUTIONS
Module will not fit into slot	<ul style="list-style-type: none"> The Module is designed to be inserted one way only 	<ul style="list-style-type: none"> Rotate the Module 180 degrees and it will fit
Unit Does Not Turn On	<ul style="list-style-type: none"> Module is missing or not fully inserted Batteries are not property installed Batteries are dead or are missing 	<ul style="list-style-type: none"> Insert or Re-insert module properly Re-orient batteries properly Replace batteries
Difficult to Peel Off the Pads Liner	<ul style="list-style-type: none"> Peel the liner from the Tab End Gently bend over the Connector to start separation Peel with thumb if necessary Remove and throw away liner 	<ul style="list-style-type: none"> Refer to the Assembly Section
Both pads attached to Manikin but device will not advance to Analysis	<ul style="list-style-type: none"> Operational solution Pad is inserted upside down in the cable connector. Adhesive worn out 	<ul style="list-style-type: none"> Insure Pads are being pressed on firmly Flip pad around and secure with black pad pin Replace pad
Pad pulls out from pad connector	<ul style="list-style-type: none"> Check for black pad pin missing 	<ul style="list-style-type: none"> Install new black pad pin
Lid will not stay closed	<ul style="list-style-type: none"> Pads Case is not placed in proper position Wires not properly stored in compartment under Case - Wire may be caught under edge of Pads Case Pads Case Front & Back not properly closed 	<ul style="list-style-type: none"> Re-seat pads case Re-coil the wires Snap case together on all 4 corners
Device Proceeds to Analyzing before both pads have been placed on the manikin	<ul style="list-style-type: none"> Pads not properly positioned in Case Look for pad riding up pad case wall 	<ul style="list-style-type: none"> Re-position pad in case to lay completely flat so it is not touching side walls

Prestan professional AED TRAINER



Device Delivers Shock before Shock button is pressed	<ul style="list-style-type: none"> • Device is In Automatic mode 	<ul style="list-style-type: none"> • Change back to Semi-Automatic Mode
Play Button on remote will not turn on Device	<ul style="list-style-type: none"> • Remote does not turn on device. 	<ul style="list-style-type: none"> • Use On/Off button to turn on then use remote
Device prompts "Replace Batteries"	<ul style="list-style-type: none"> • Device will run 10 or more hours with low batteries 	<ul style="list-style-type: none"> • Replace batteries within 10 hours
Device suddenly shuts down or distorted voice prompts	<ul style="list-style-type: none"> • Batteries are very low, almost dead 	<ul style="list-style-type: none"> • Install new batteries
Remote Buttons do not work	<ul style="list-style-type: none"> • If AED Trainer is off, remote doesn't work • Remote not pointed at AED Trainer • Too much distance from AED Trainer • Improperly installed batteries • Dead batteries 	<ul style="list-style-type: none"> • Turn AED Trainer on then use remote • Point remote at device • Operate remote within proper distance (9 feet/3 meters) • Check orientation of batteries • Install new batteries

Warranty

One Year Limited Warranty

1. **WARRANTY COVERAGE.** The manufacturer offers a LIMITED WARRANTY against any defects in workmanship or materials under normal use with respect to its PRESTAN PROFESSIONAL AED TRAINER.
2. **WARRANTY PERIOD.** The manufacturer warrants the PRESTAN PROFESSIONAL AED TRAINER for one (1) year from the date of purchase. Any component of the PRESTAN PROFESSIONAL AED TRAINER which proves defective within twelve (12) months from the date of purchase will be repaired or replaced, at the manufacturer's option, free of charge to the owner. The owner is responsible for shipping and handling fees to the place which the manufacturer designates.
3. **WARRANTOR'S RESPONSIBILITIES.** The manufacturer will repair or replace at (the manufacturer's option) a defective warranted component subject to the provisions of Section 2 without charge except for transportation costs. OWNER'S SOLE AND EXCLUSIVE REMEDY AGAINST THE MANUFACTURER SHALL BE FOR THE REPAIR OR REPLACEMENT OF DEFECTIVE GOOS AS PROVIDED HEREIN. Repair or replacement of any component of any PRESTAN PROFESSIONAL AED TRAINER does not extend this limited warranty or begin a new limited warranty period.
4. **CIRCUMSTANCE NEGATING WARRANTY AND OTHER LIMITATIONS.**
 - a. The manufacturer reserves the right to refuse warranty service or replacement when product failure is due to misuse, mishandling, misapplication, accident, neglect, improper installation, modification, use of unauthorized parts or attachments, adjustments or repair performed by anyone other than the manufacturer or its authorized agent, or any causes other than defective workmanship or material.
 - b. This limited warranty does not cover abrasion, abnormal use, damage caused by mishandling, neglect or unauthorized modification. This warranty is void if the PRESTAN PROFESSIONAL AED TRAINER MANIKIN is structurally altered.
 - c. Owner must provide proof of the date of purchase, place of purchase and the purchase price in order to obtain service under this limited warranty.
 - d. The manufacture makes no warranty other than as contained herein. No agent, representative, dealer or employee of the manufacturer has the authority to alter the obligations or limitations of this limited warranty.
5. **LIMITATIONS OF IMPLIED WARRANTIES AND DAMAGES**
 - a. Any and all implied warranties on the PRESTAN PROFESSIONAL AED TRAINER, INCLUDING ANY IMPLIED WARRANTY OF MERCHANTABILITY OR FITNESS FOR A PARTICULAR PURPOSE, SHALL NOT EXCEED IN DURATION THE RESPECTIVE TERMS OF THIS LIMITED WARRANTY WHICH BEGIN WITH THE DATE OF PURCHASE. Some states do not allow limitations on how long an implied warranty lasts, so the above limitation may not apply to you.
 - b. THE MANUFACTURER SHALL NOT BE LIABLE FOR INCIDENTAL OR CONSEQUENTIAL DAMAGES ARISING OUT OF THE USE OF THE PRESTAN PROFESSIONAL AED TRAINER OR THE BREACH OF THIS OR ANY OTHER EXPRESSED OR IMPLIED WARRANTY. Some states do not allow the exclusion or limitation of incidental or consequential damages, so the above limitation or exclusion many not apply to you. Any and all damages awarded for any breach of this limited warranty shall be limited to the amount of the purchase price.
6. **WARRANTY SERVICE.** To obtain warranty service or information about the manufacture, contact the manufacturer, 701 Beta Drive, Suite 2, Mayfield Village, Ohio 44143 — or callus tool free at 1-800-434-7989
7. **RIGHTS UNDER STATE LAW.** This warranty gives you specific legal rights and you may have other rights which vary from State to State.